

TECHNICAL DATA : SMV 10-600 C

LIFTING DATA			
Lifting capacity / Load center (up to 7 000 mm / standard mast)	kg / mm	10 000 / 600	
Lifting speed, unloaded / at rated load	m/s	0,5 / 0,45	
Lowering speed, unloaded / at rated load	m/s	0,4 / 0,4	
DRIVING DATA			
Drive speed forward, unloaded / at rated load	km/h	30 / 30	
Drive speed reverse, unloaded / at rated load	km/h	30 / 30	
Incline (driving ability) at rated load at 0 km/h/at 2 km/h	%	44 / 35	
Towing (power ability) at rated load at 0 km/h/at 2 km/h	kN	108 / 86	
SERVICE WEIGHT / AXLE PRESSURE			
Service weight	kg	14 800	
Axle pressure front, unloaded / at rated load	kg	7 900 / 22 600	
Axle pressure rear, unloaded / at rated load	kg	6 900 / 2 200	
ENGINE (electronic controlled)			
Engine make / model name		Volvo TAD-871-VE	
Emission approval EU / US		Stage 4 / Tier 4f	
Monitoring / emission controlled / CanBus		Yes / yes / yes	
Fuel / type of engine / intercooler		Diesel/4-stroke/ yes	
Power ISO 3046 / max speed	kW / rpm	185 / 2 200	
Torque ISO 3046 / at speed	Nm / rpm	1 160 / 1 500	
Displacement / No. of cylinders / type	L / /	7,7 / 6 / Inline	
Fuel consumption, normal driving	L/h	7 – 10	
Alternator, type/power	W / Amp	AC / 3 080 / 110	
Starting battery, voltage/capacity	V / Ah	2 x 12 / 140	
TRANSMISSION (electronic controlled)			
Transmission make / model name		ZF 4WG-191-A	
Monitoring / reverse protection / CanBus		Yes / yes / yes	
Clutch, type		Torque converter	
Transmission type / type of shift gear		Softshift – Powershift / Automatic	
No. of gears, forward/reverse		3 / 3	
DRIVE AXLE & STEER SYSTEM			
Drive axle make / model name		Kessler D81	
Drive axle type / drive axle width	/ mm	Differential + hub reduction / 2 500	
Service brake system, type / affected wheels		Oil cooled Wet Disc Brakes / drive wheels	
Parking brake system, type / affected wheels		Dry disc brake / spring release / drive wheels	
STEER AXLE & STEER SYSTEM			
Steer axle make / type		Konecranes / double acting single cylinder	
Steering system		Hydraulic servo assisted / power steering	
WHEELS			
Number of wheels, front+rear / Type (*driven)		4*+2 / pneumatic	
Tire pressure front / rear	MPa	0,9 / 0,9	
Tire dimensions (Ply rating) front / rear	Inch (No)	11.00 x 20" (PR 18) / 11.00 x 20" (PR 18)	
Rim dimension front / rear	Inch	8.00 x 20" / 8.00 x 20"	
HYDRAULIC SYSTEM			
Hydraulic pump make / model name		Parker & Hannifin / P2-series	
Hydraulic system / pump type		Load sensing system / variable piston pump	
Power-on-demand / Low energy		Yes / yes	
Hydraulic oil pressure mast	MPa	22	
TANK VOLUMES			
Diesel tank volume	L	131	
Hydraulic tank volume	L	152	
LIFTING EQUIPMENT			
Lift mast make / model		Konecranes / Duplex standard	
Lift mast type / design		2-stage / free visibility	
Fork carriage make / model		Konecranes / integral double forks	
Fork carriage type		Hydraulic side shift & fork positioning	
OTHERS			
Noise level (inside Cab / Lm)	DIN 45635	dB(A)	66
Noise level (inside Cab/ LpAZ)	EN 12053	dB(A)	72
Noise level (outside at 7 m/ Lwa)	2005/88/EC	dB(A)	109
NORMS & STANDARDS			
Machine Directive in Europe	2006 / 42 / EC		Yes
Stability of Industrial Trucks	ISO 1074		Yes
Safety of Industrial Trucks	EN ISO 3691-1		Yes

TECHNICAL DATA

SMV 10-600 C

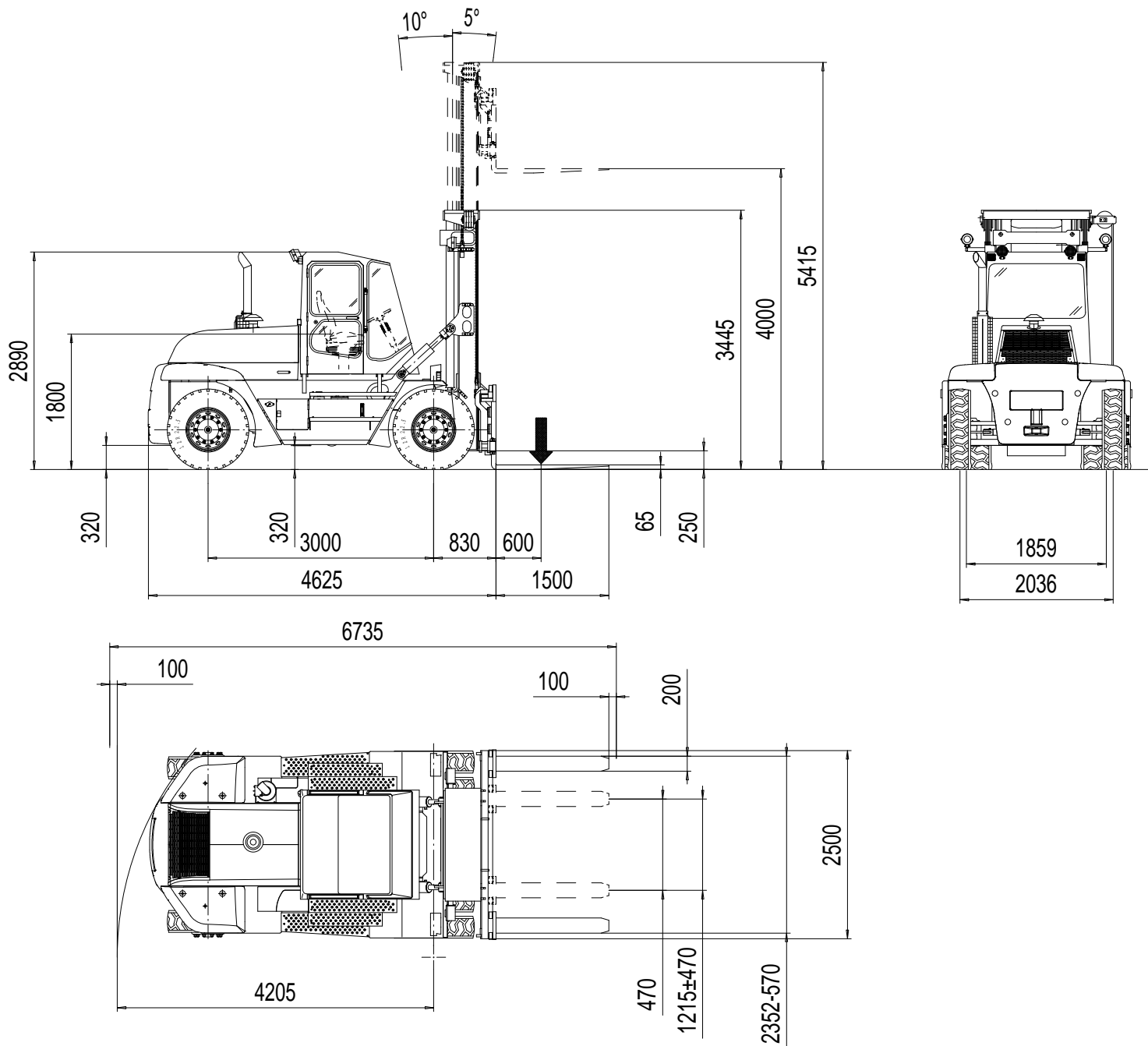

SMV 10-600C

